

# S430 - KS430

## SEATLOCK

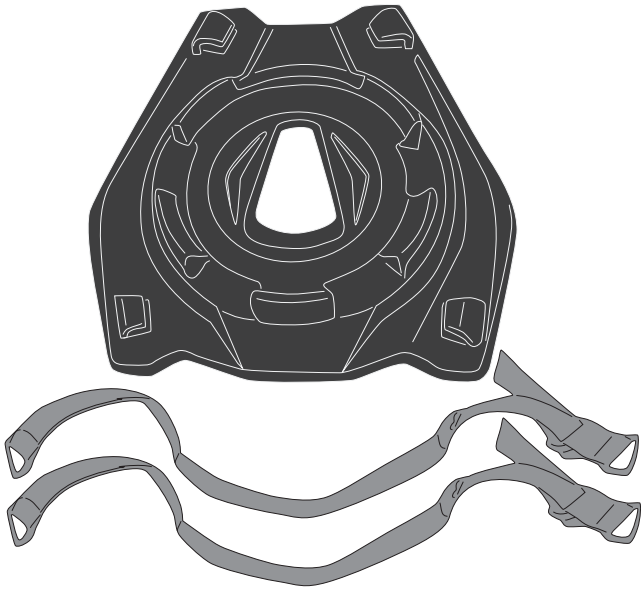

**ONLY FOR BAGS WITH FLAT BASE,  
NOT FOR THOSE WITH A CONTOURED/CURVED BASE**

**ATTENZIONE:** Verificare il corretto aggancio prima di mettersi in marcia.  
**WARNING:** Fasten securely before setting off.  
**ATTENTION:** Vérifier la bonne accroche avant la mise en route.  
**ACHTUNG:** Prüfen Sie bitte die Befestigung bevor Sie fahren  
**ATENCIÓN:** Comprobar si esta correcto el anclaje antes de ponerse en marcha.  
**ATENÇÃO:** Verificar se correta fixação antes de começar.

### MOUNTING ON SADDLE FIRST OPTION

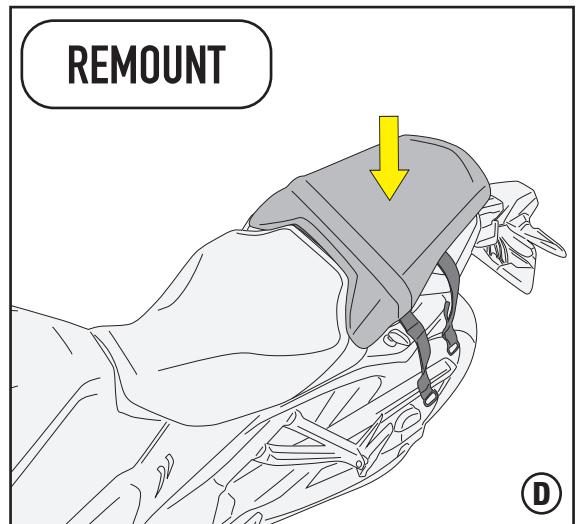
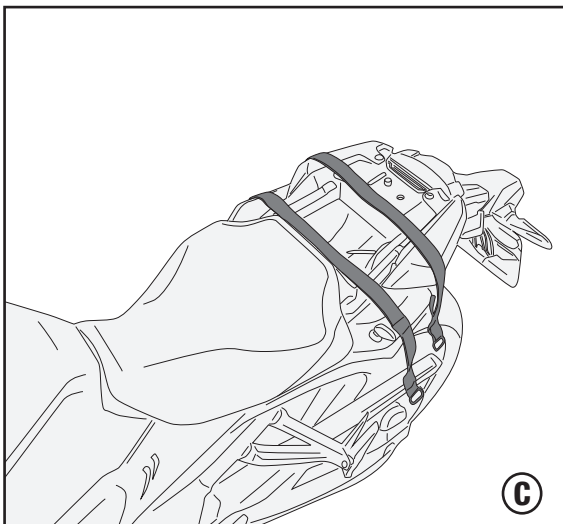
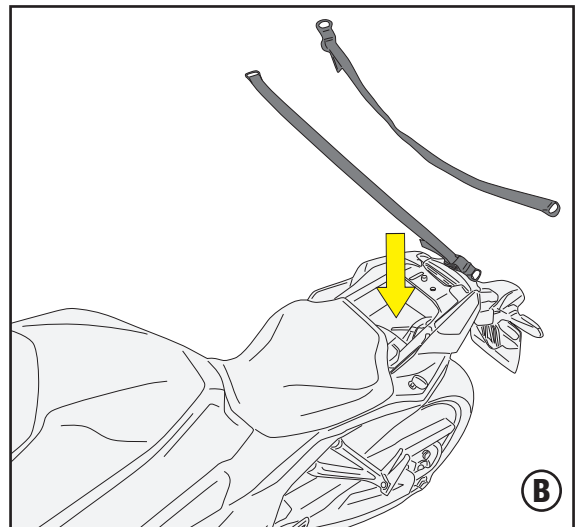
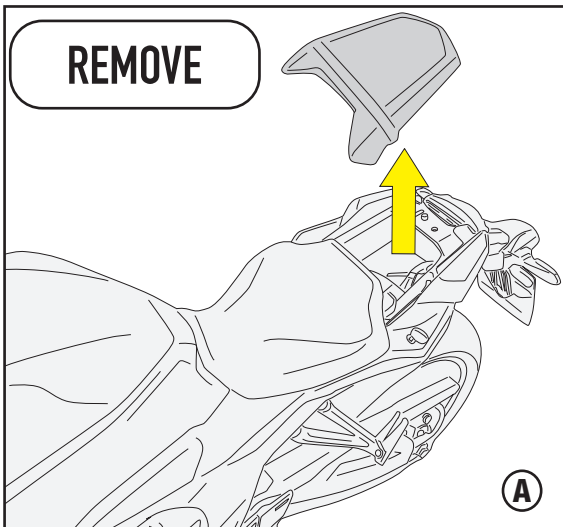

# S430 - KS430

## SEATLOCK

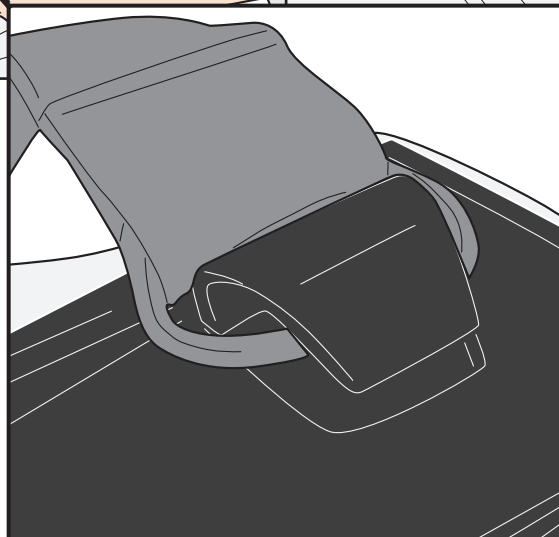
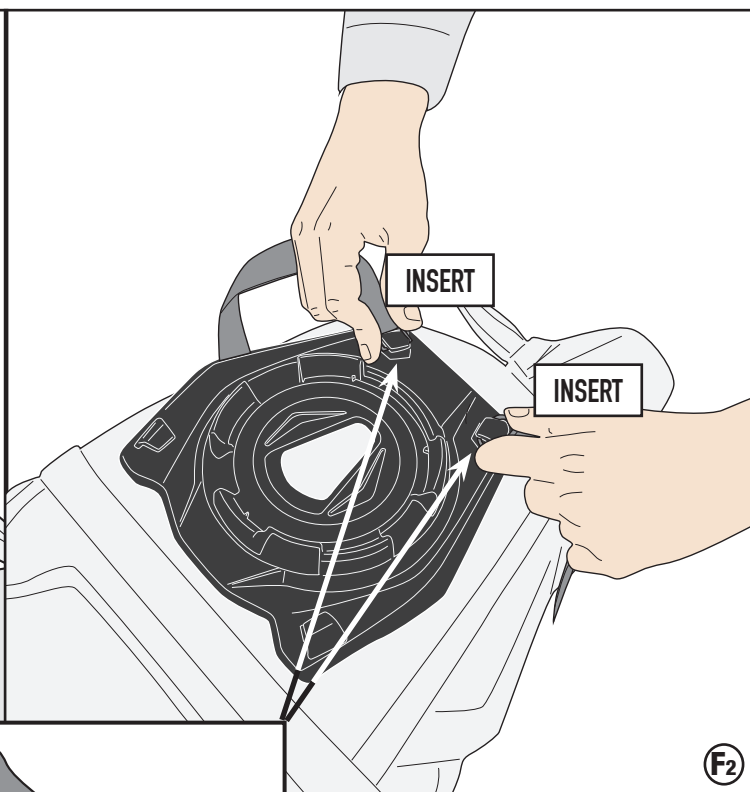
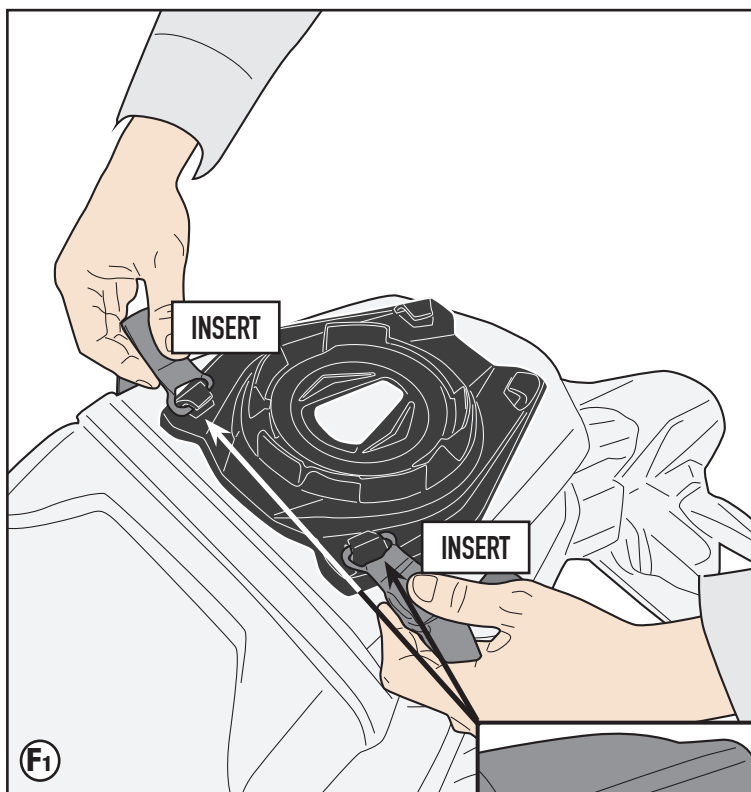
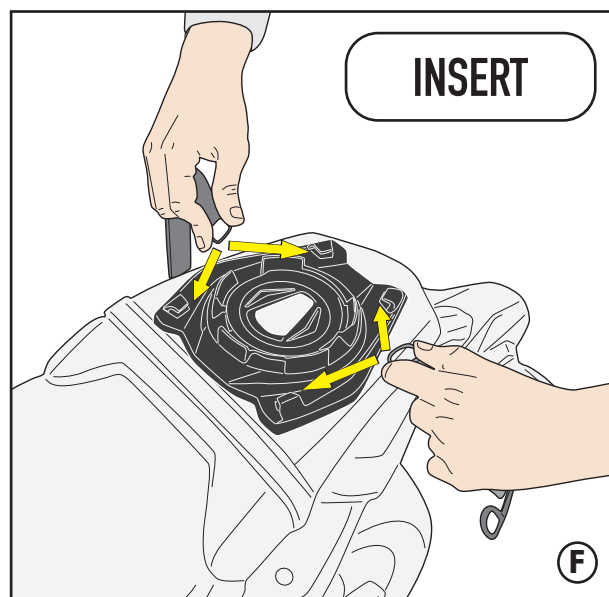
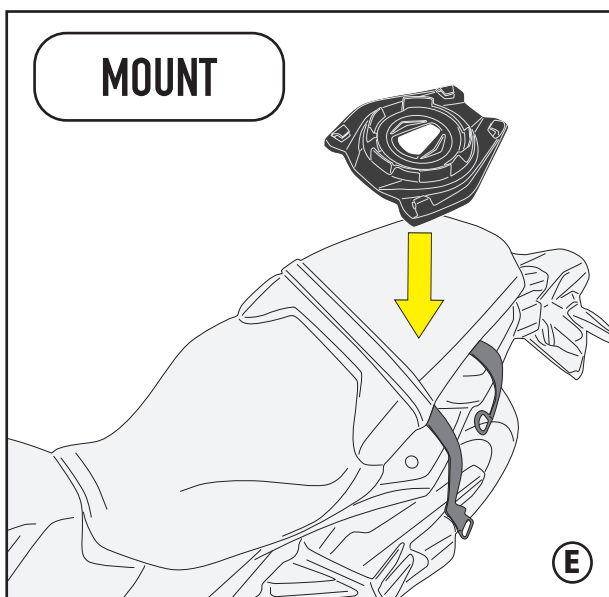

# S430 - KS430

## SEATLOCK

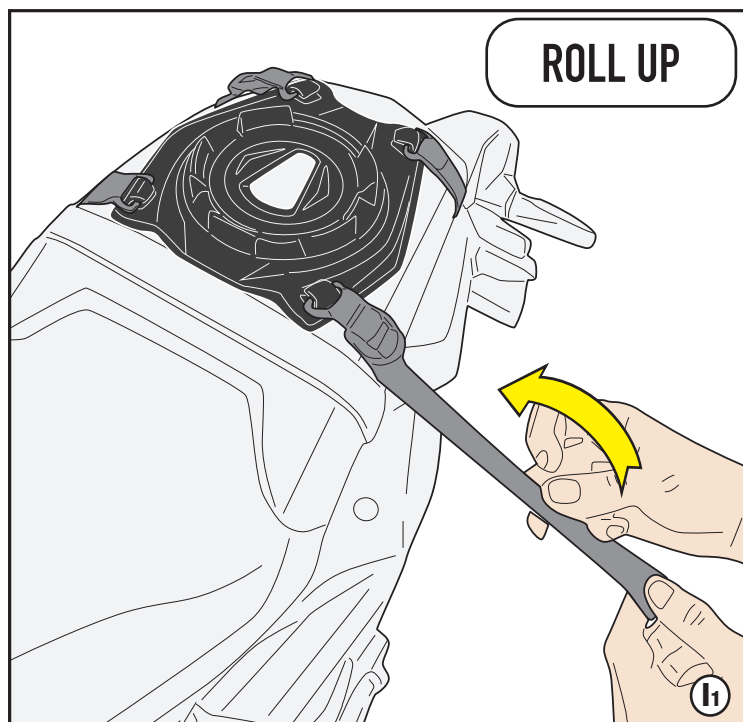
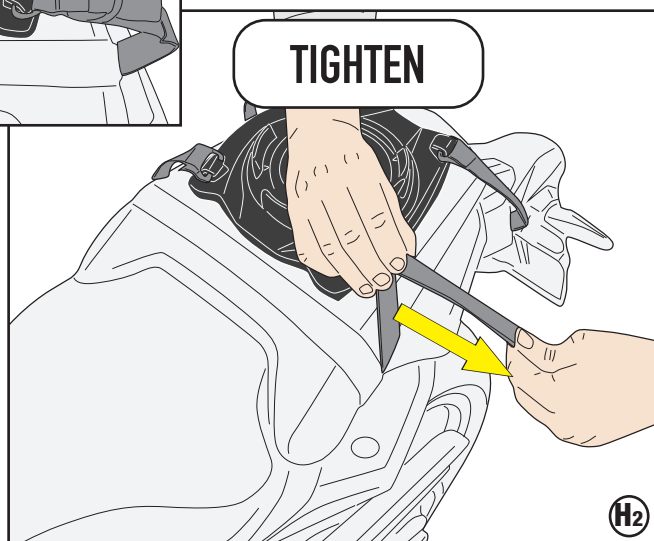
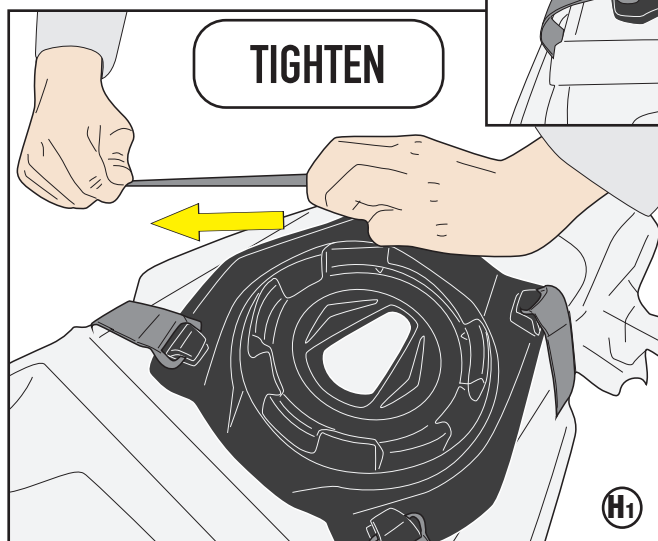
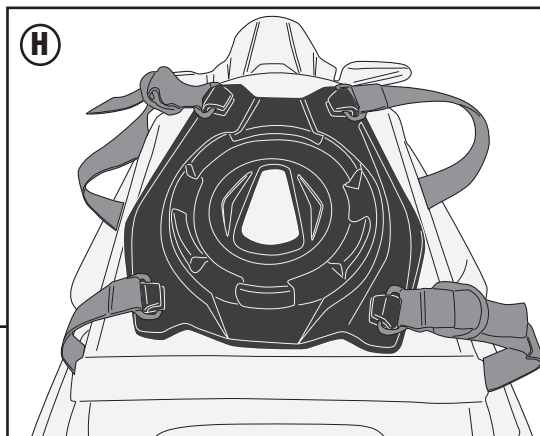

# S430 - KS430

## SEATLOCK

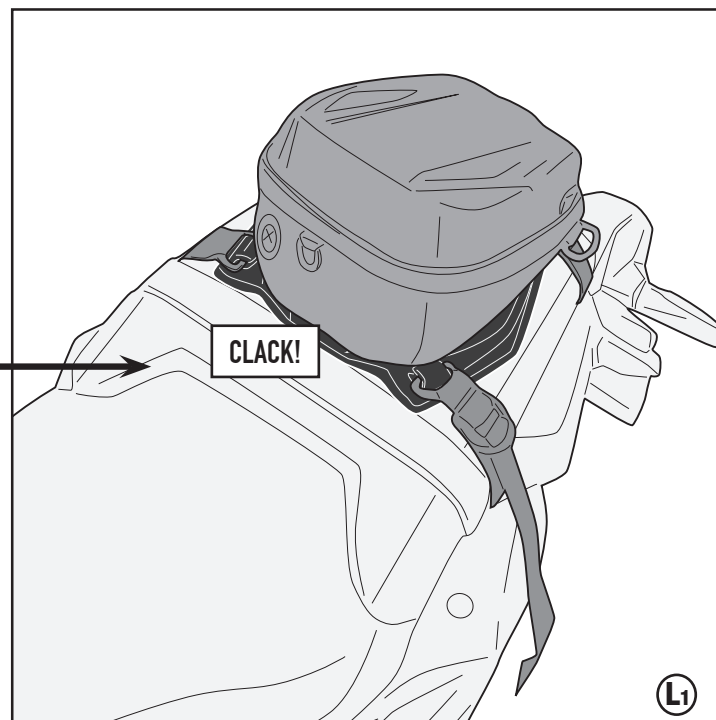
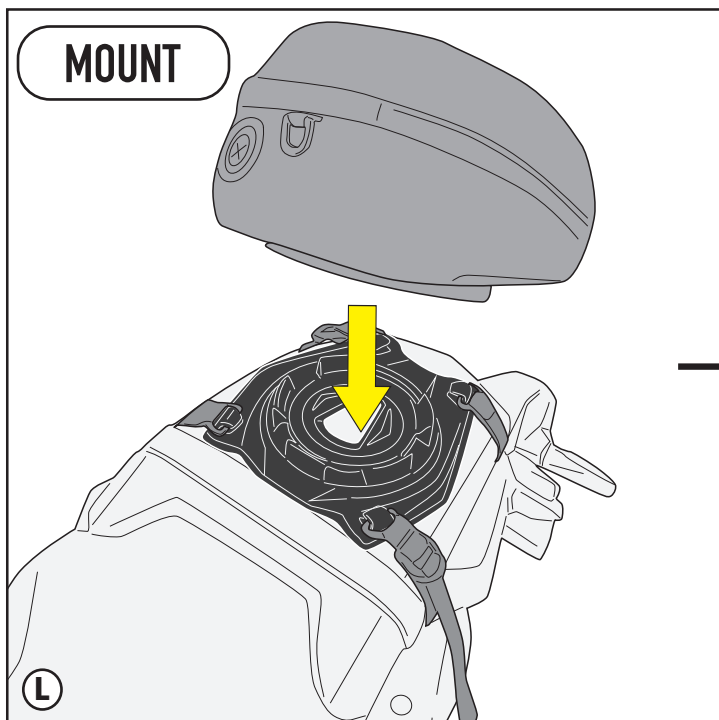
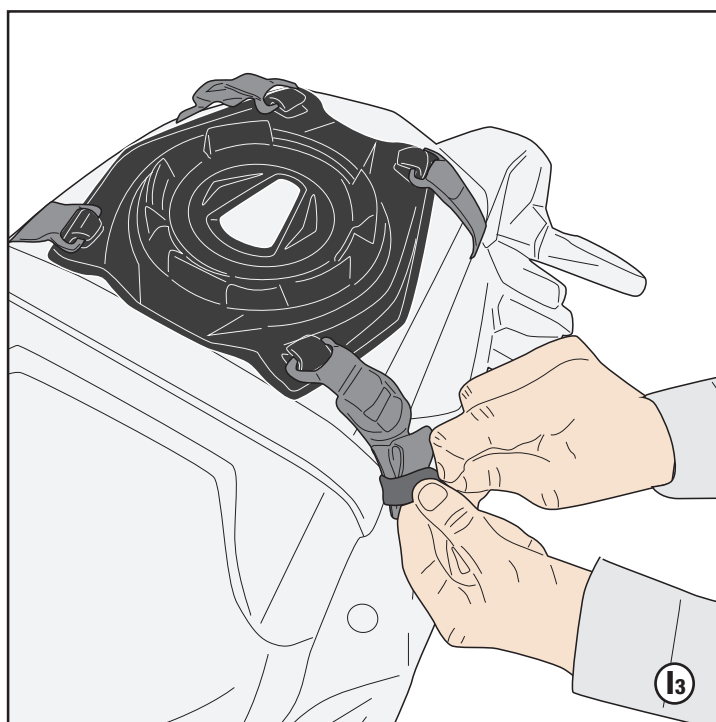
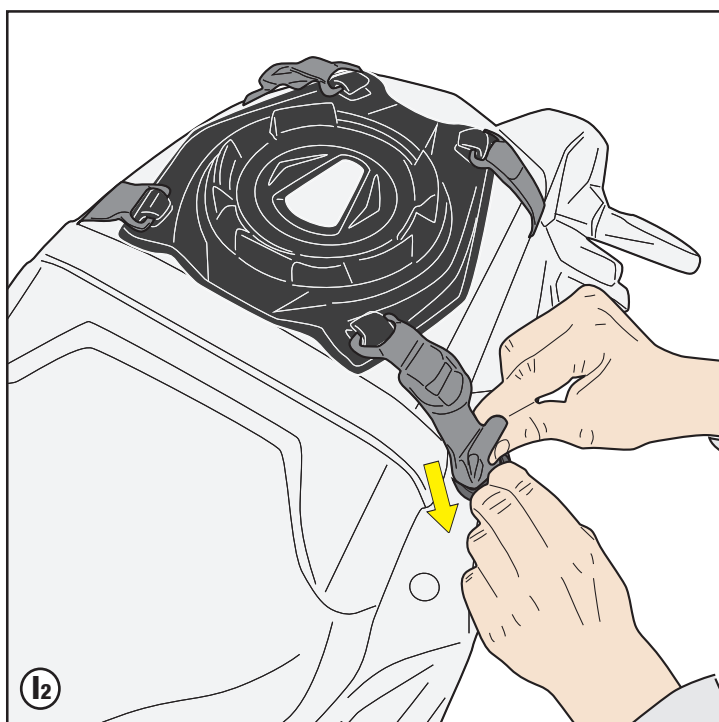

# S430 - KS430

## SEATLOCK

### MOUNTING ON SADDLE SECOND OPTION

REMOVE

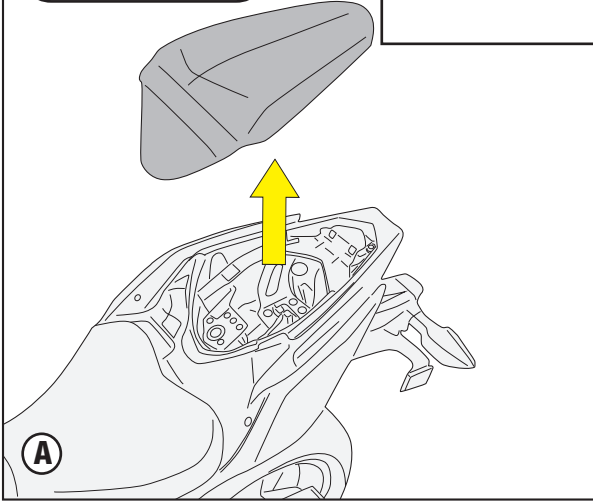

CROSSED BELTS

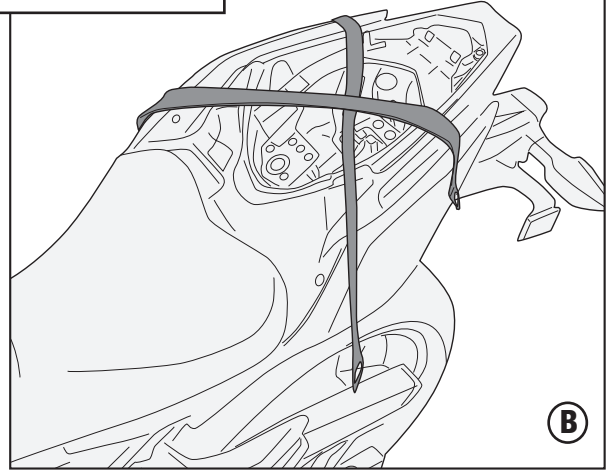

REMOUNT

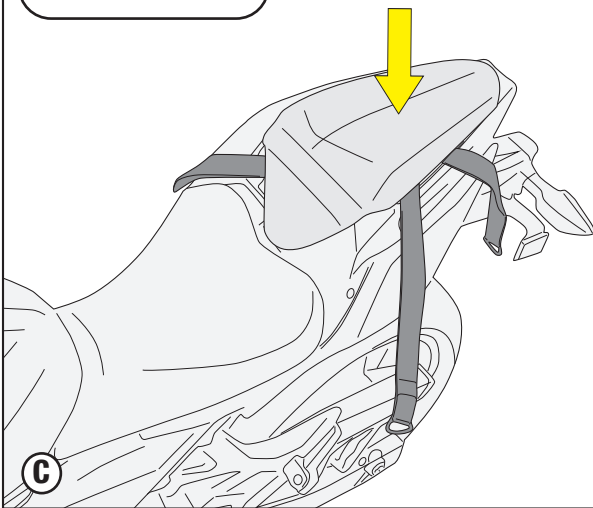

MOUNT

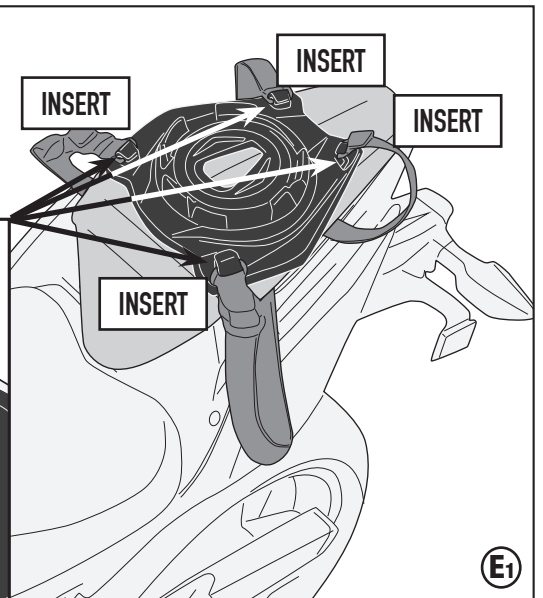
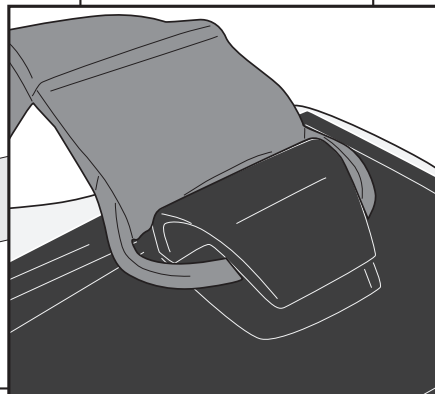
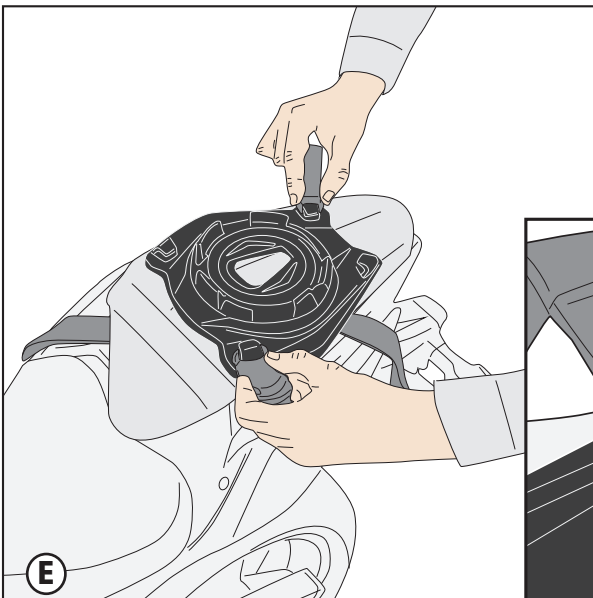
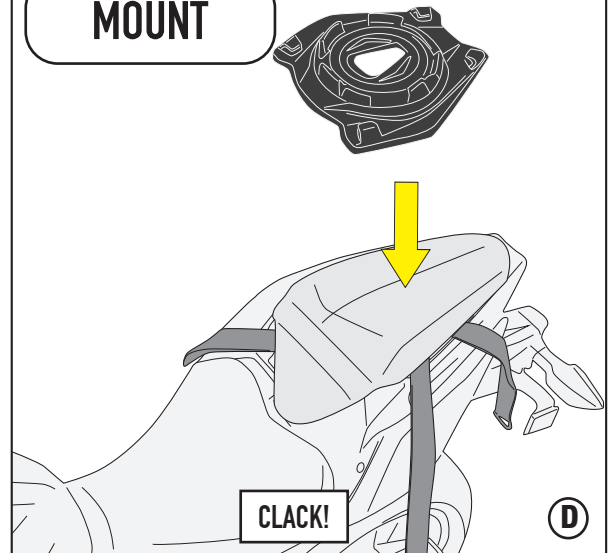

# S430 - KS430

## SEATLOCK

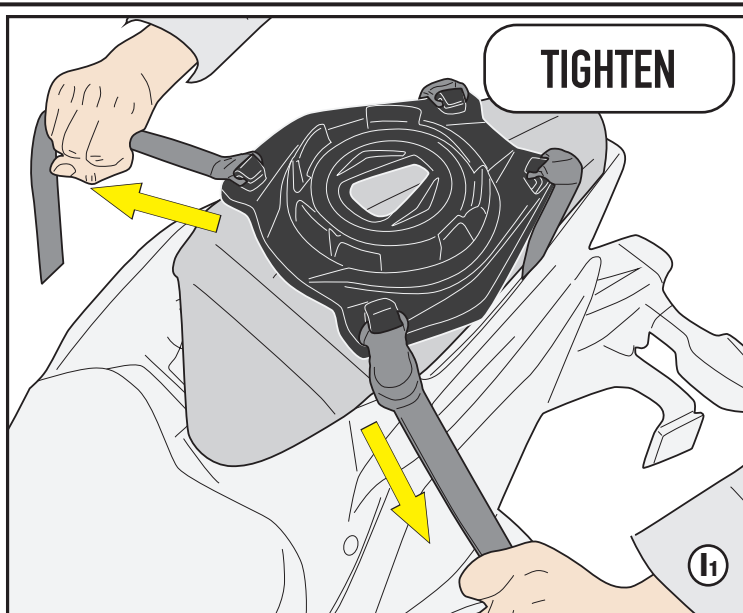
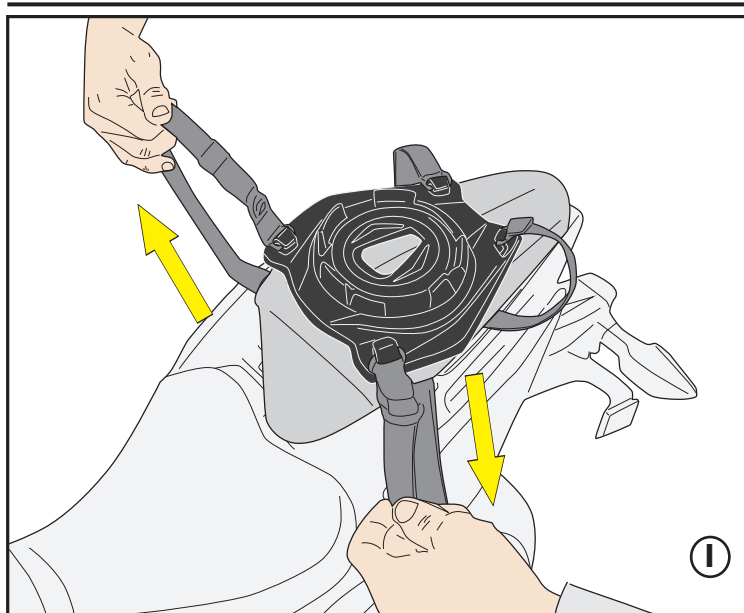

## MOUNTING ON PLATE

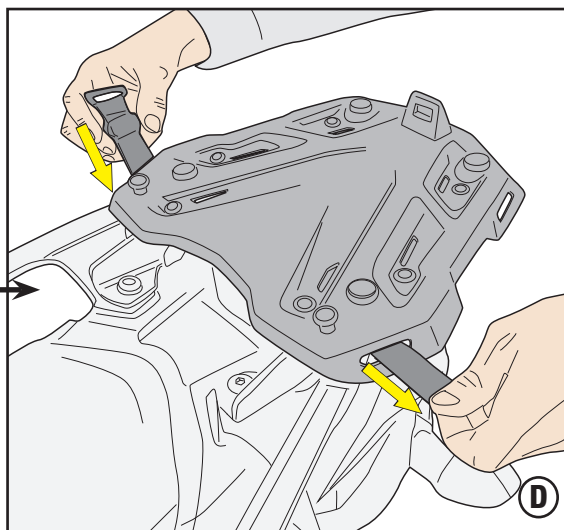
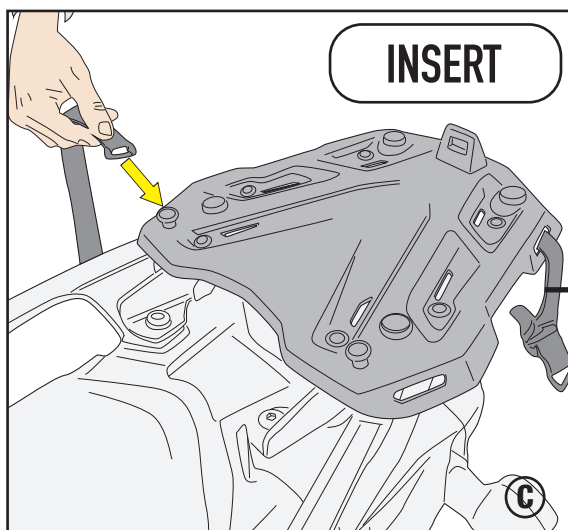
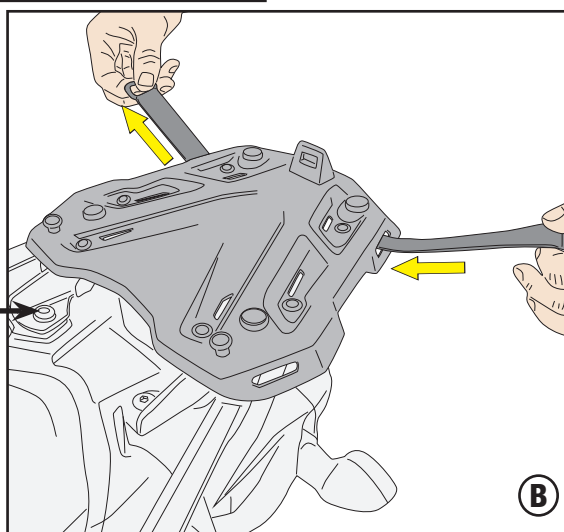
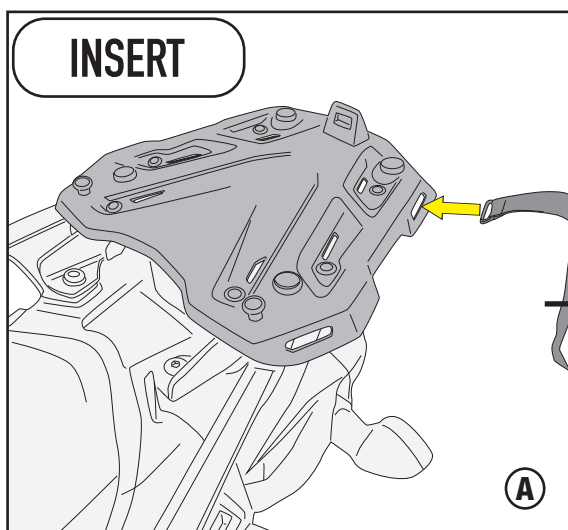

# S430 - KS430

## SEATLOCK

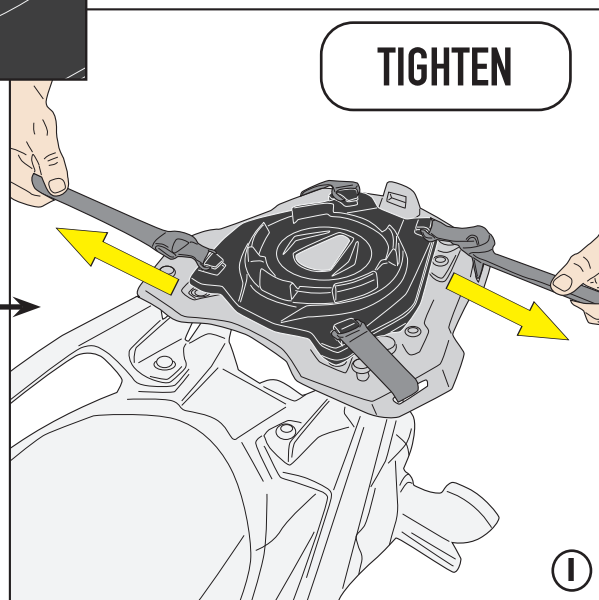
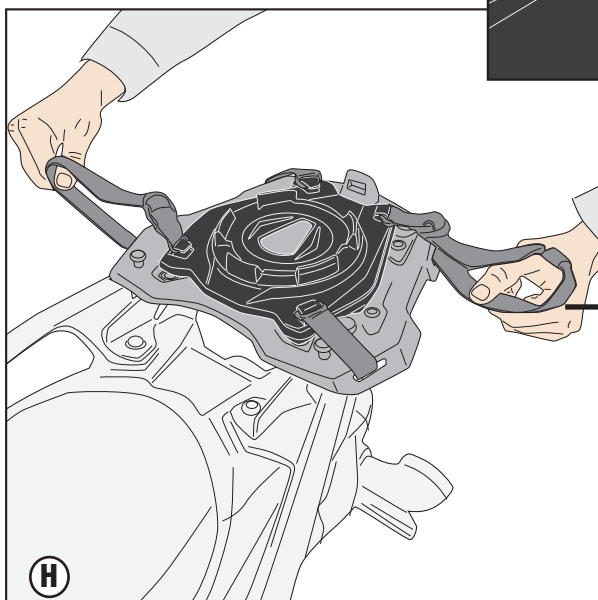
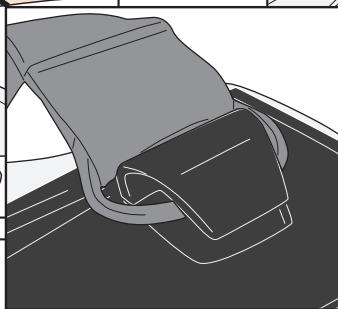
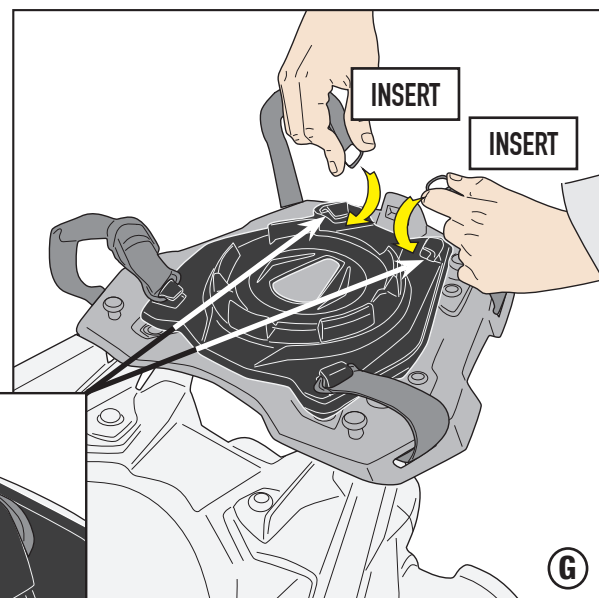
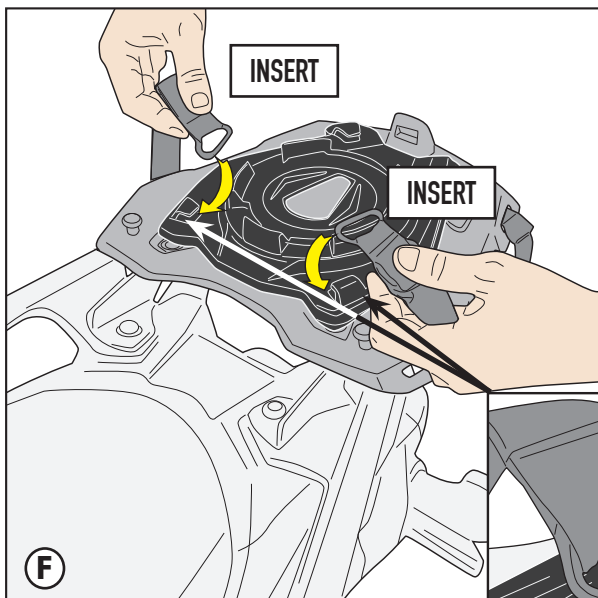
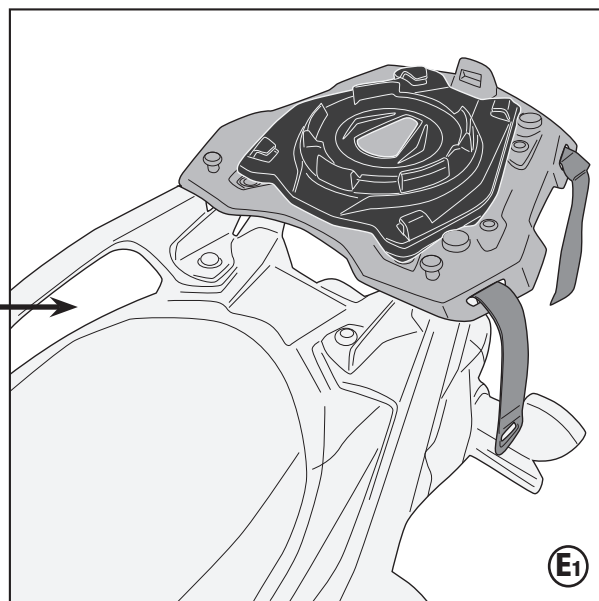
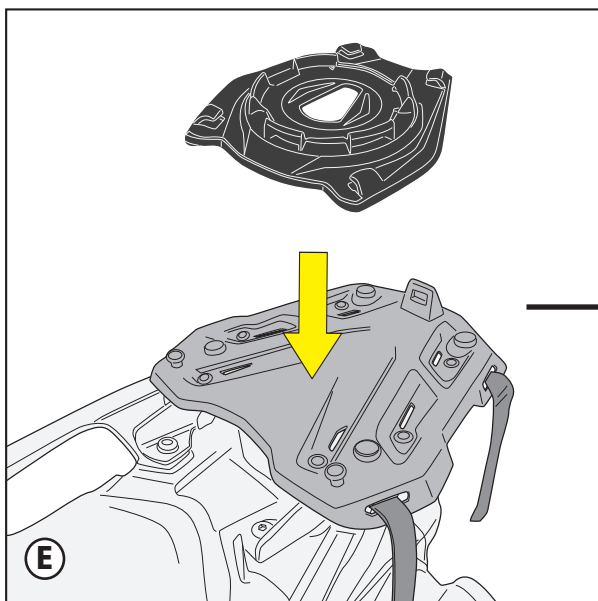

# S430 - KS430

## SEATLOCK

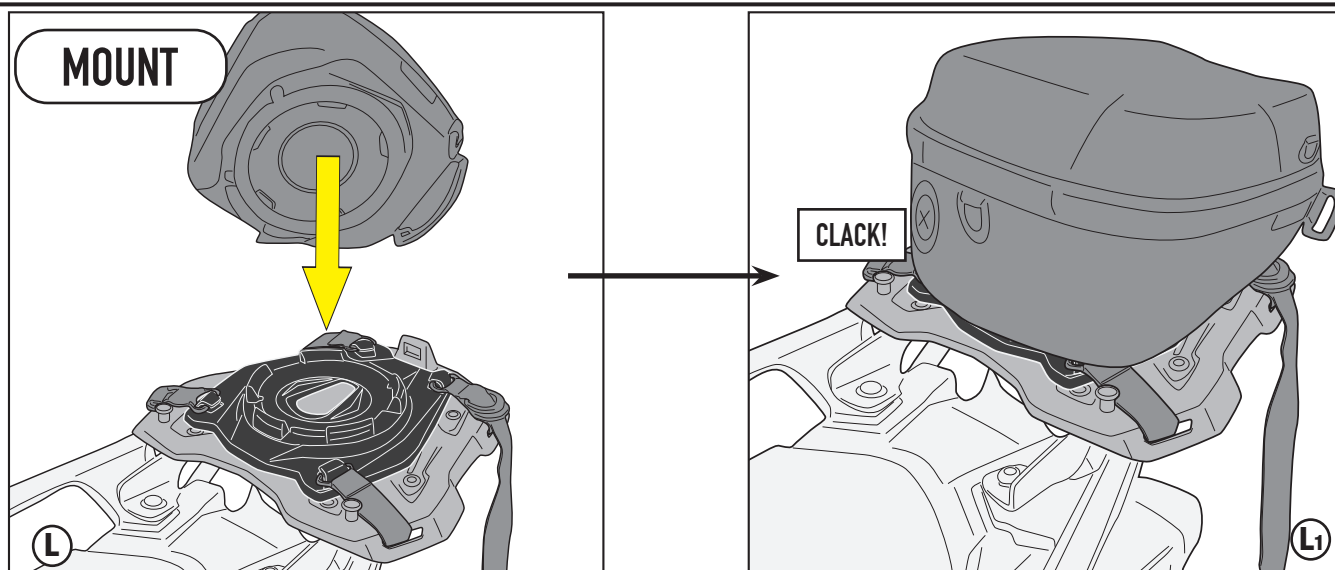

- VERIFICARE ATTENTAMENTE CHE LA BORSA NON PREGIUDICI L'ORIGINARIA GUIDABILITÀ DEL MEZZO
- PLEASE CHECK CAREFULLY THAT THE BAG WILL NOT EFFECT THE ORIGINAL DRIVEABILITY
- BITTE PRÜFEN SIE DASS DIESES MODELL DIE ORIGINALFAHRT DES FAHRZEUGES NICHT BEEINTRÄCHTIGT
- VEUILLEZ VÉRIFIER SOIGNEUSEMENT QUE LA SACOCHE N'AFPECTERA PAS LA MANIABILITÉ DU VÉHICULE
- VERIFICAR ATENTAMENTE QUE LA BOLSA NO PERJUDIQUE LA ORIGINAL CONDUCCIÓN DEL VEHÍCULO
- VERIFICAR CUIDADOSAMENTE QUE A BOLSA NÃO PREJUDIQUE A CONDUÇÃO ORIGINAL DO VEICULO

## SECURITY BELT

### FIRST OPTION

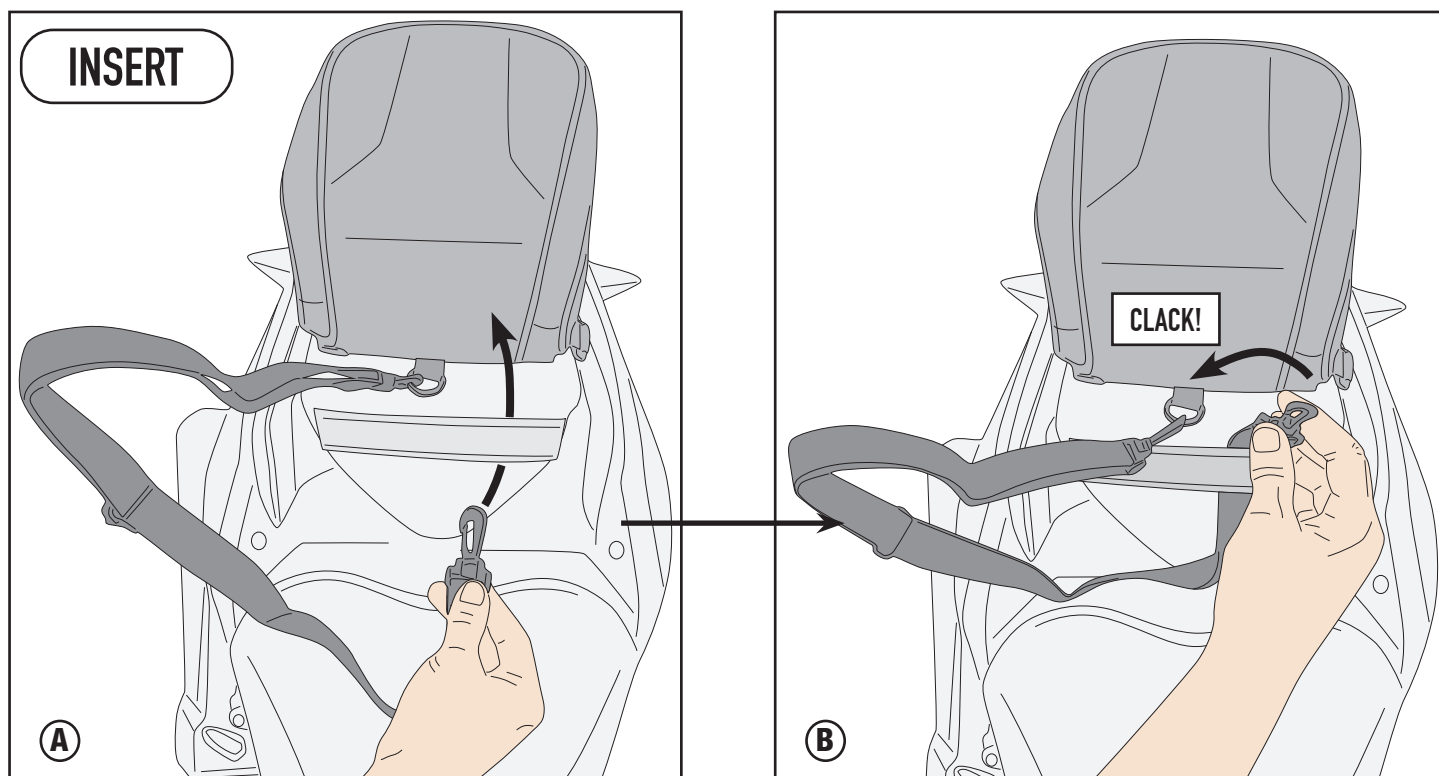



# S430 - KS430

## SEATLOCK

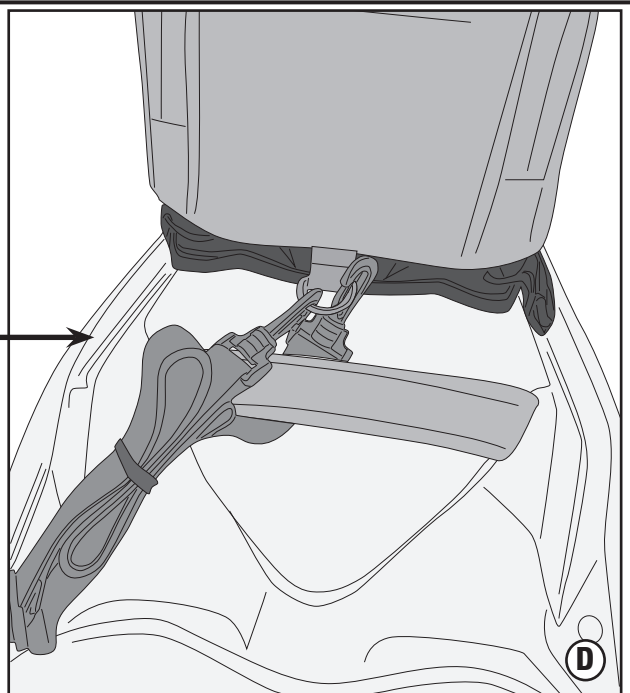
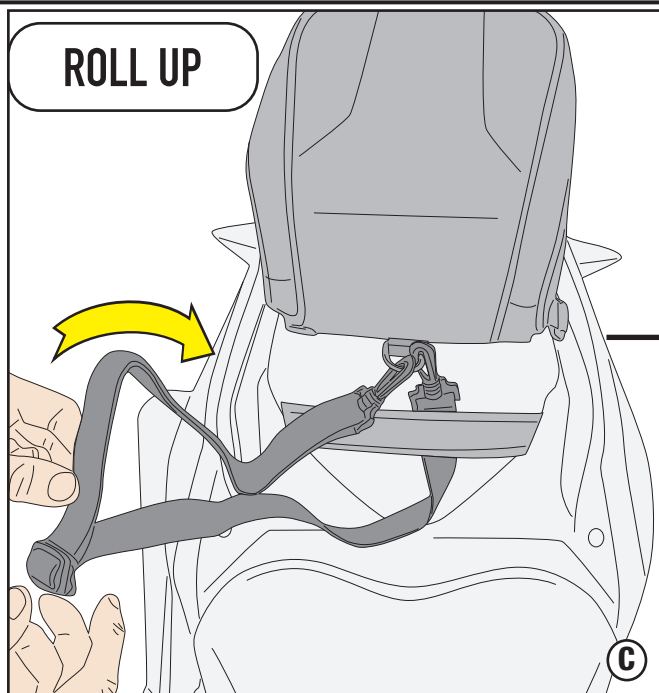

### SECOND OPTION

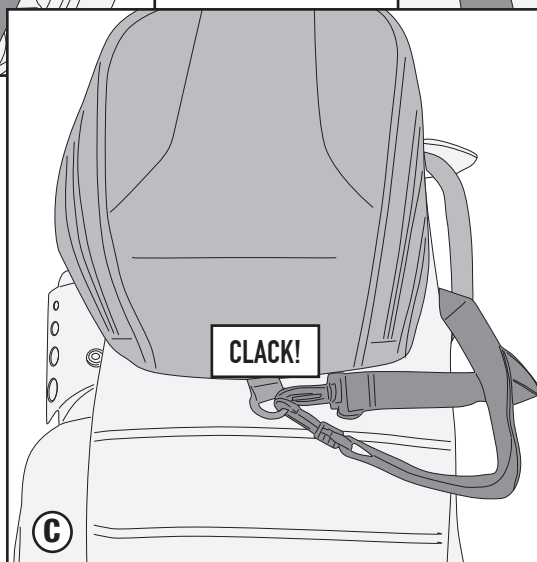
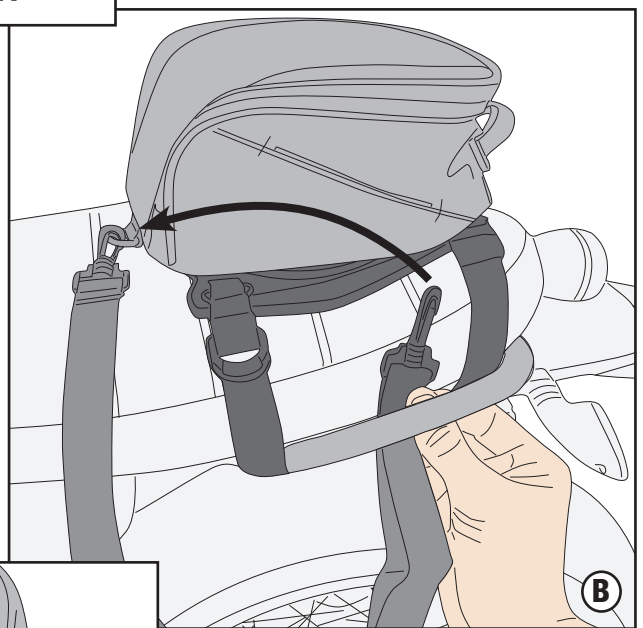
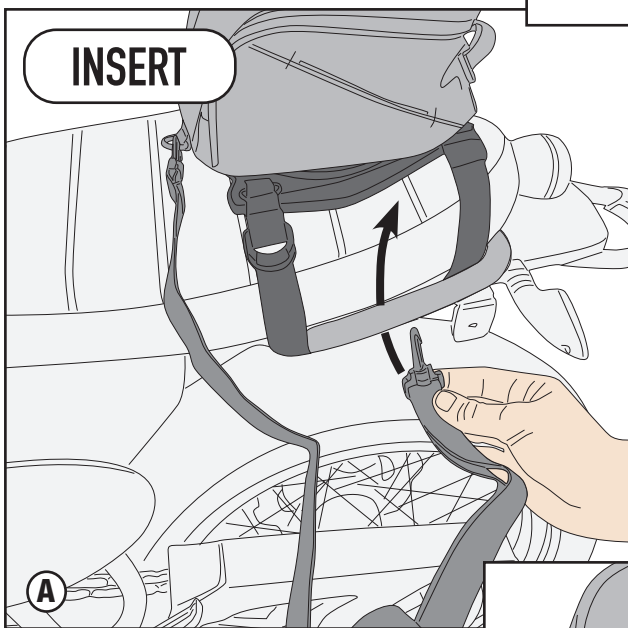

# S430 - KS430

## SEATLOCK

INSERT

THIRD OPTION

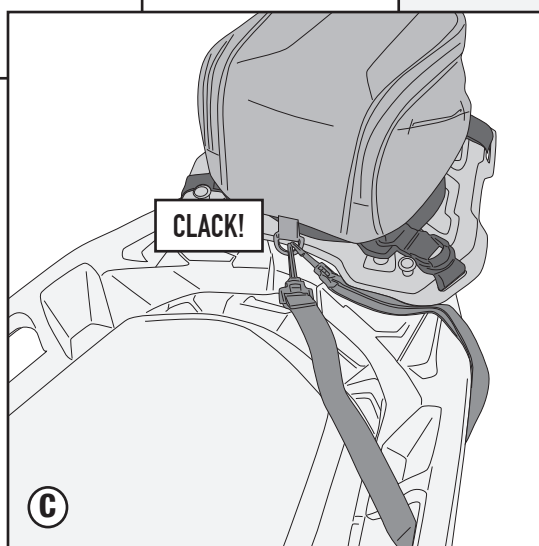
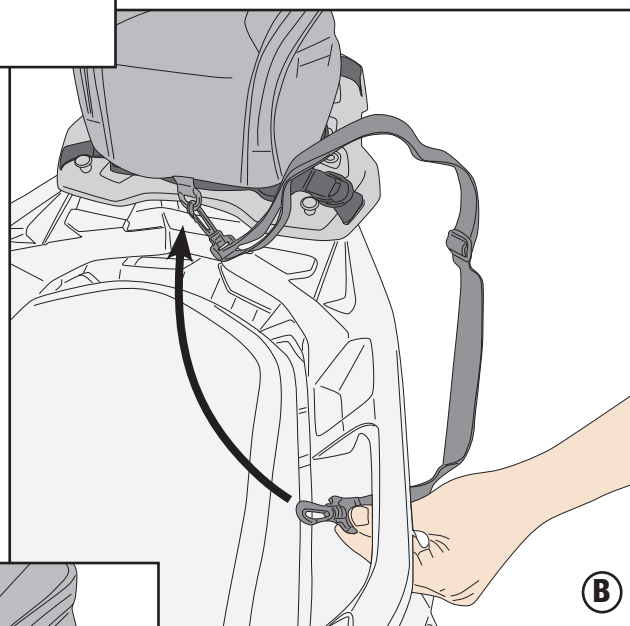
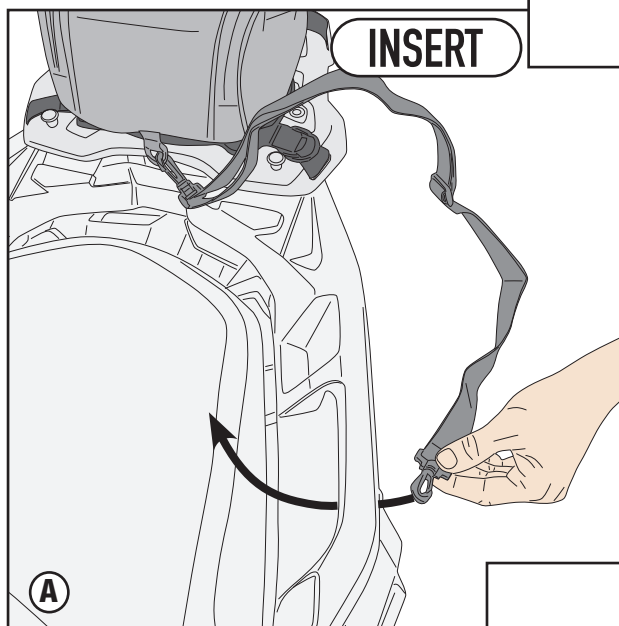

FOURTH OPTION

