

TERMOSCUO[®] PRO

ISTRUZIONI DI MONTAGGIO

Instruction manual

Honda Forza 125/300 > 2018

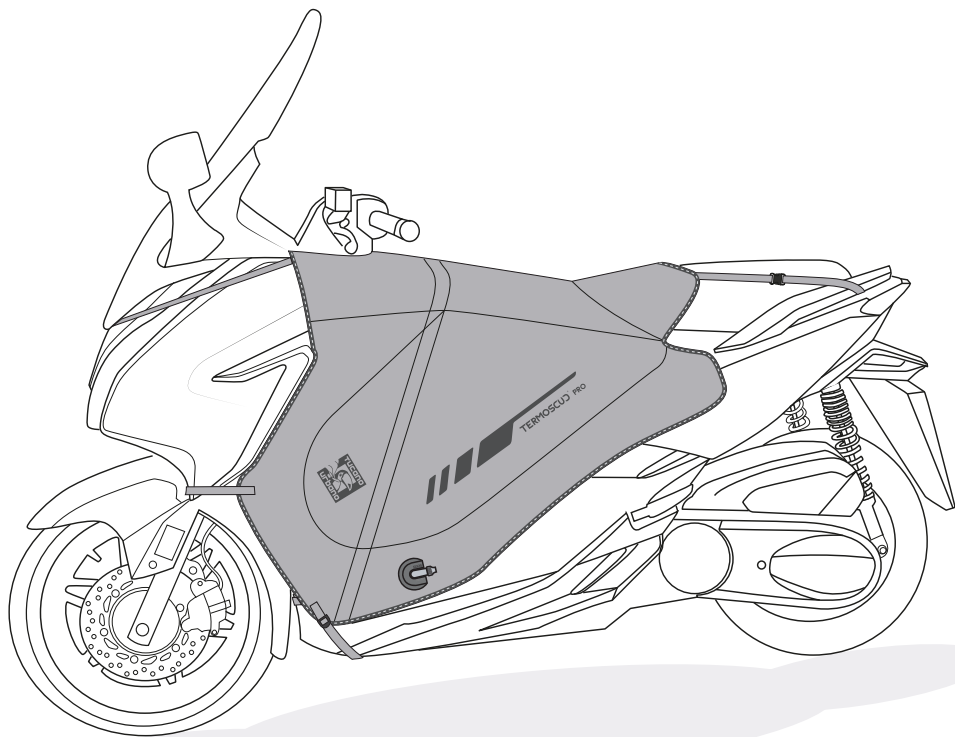

R198 PRO

VISTA RIEPILOGATIVA

Summary view

KIT DI MONTAGGIO
Assembly kit

A  x 4

B  x 4

C  x 2
Adhesive foam

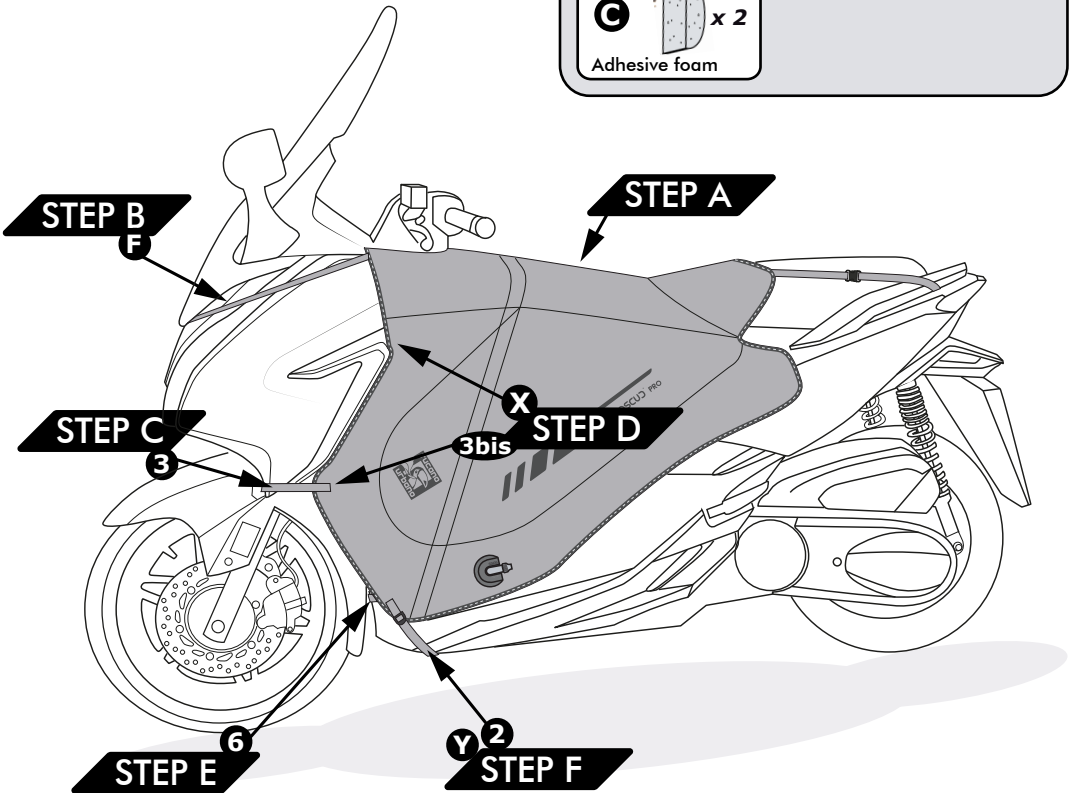

Le foto e i disegni sono puramente indicativi. Tucano Urbano si riserva il diritto di modificare o migliorare il prodotto in qualsiasi momento, senza preavviso e senza obblighi di dover applicare tali modifiche su prodotti già venduti.

Photos and drawings are purely indicative. Tucano Urbano reserves the right to modify or improve the product at any time, without prior notification and with no obligation to apply such modifications to products already sold.

TUCANOURBANO

STEP A

- I** Stendere Termoscut® sulla sella con i nastri 3 e 6 in avanti.
- GB** Unfold Termoscut® on the scooter's seat with straps 3 and 6 forward.

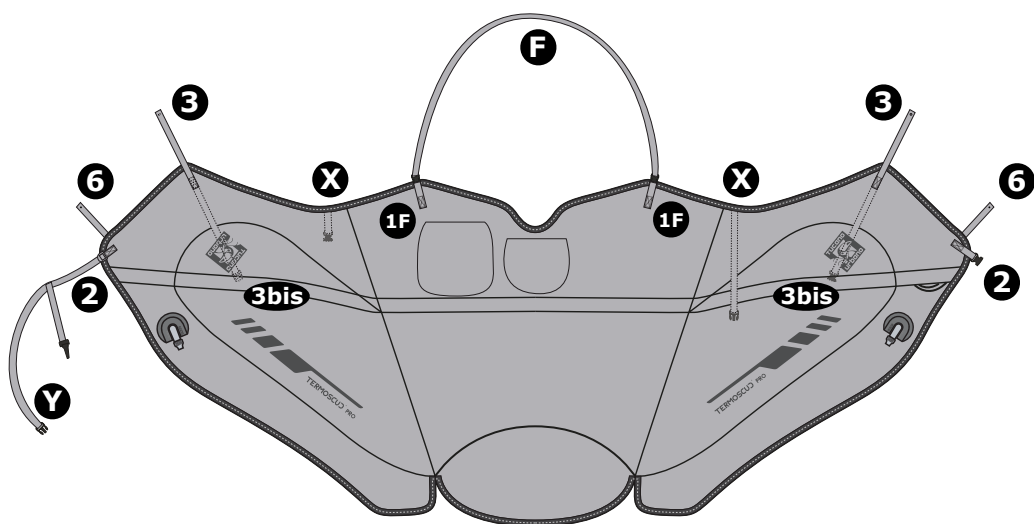

STEP B

I Infilare la prolunga F fino in fondo tra il cupolino ed il parabrezza trasparente. Quindi, agganciare gli attacchi fastex del nastro F al Termoscud® nei punti 1F.

GB Thread extension strap F as far as it will go between the fairing and the Perspex screen. Secure the Termoscud® using the fastex buckles at point 1F.

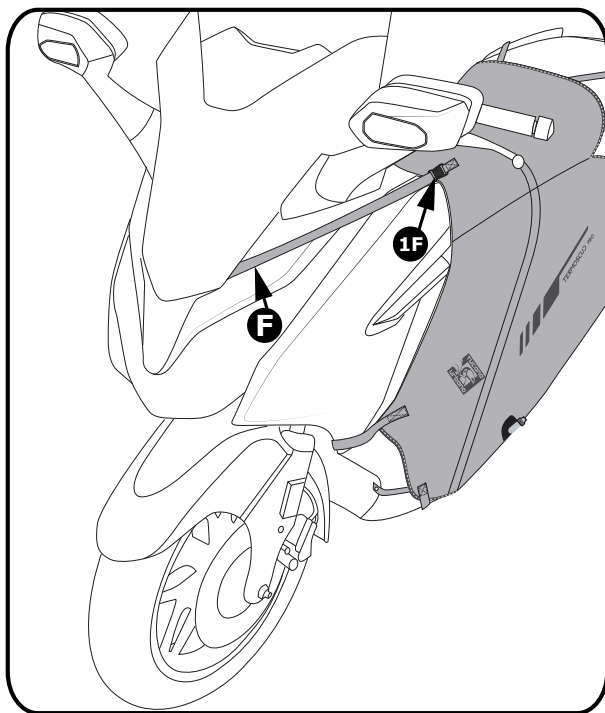

STEP C

I Rimuovere la vite in plastica dello Scrivet A. Inserire ciò che rimane nel foro 3 all'interno del vano ruota. Quindi fissare nastro 3 con la vite B.

GB Remove the plastic screw from the Scrivet A. Insert the remaining part of the Scrivet into the hole 3 inside the wheel compartment. Then fasten the strap 3 with screw B.

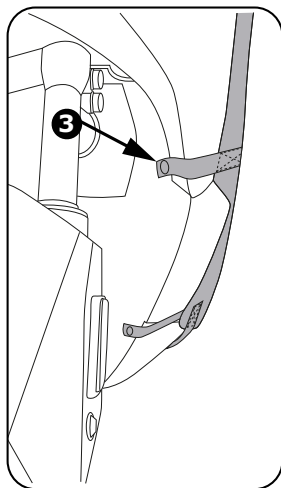
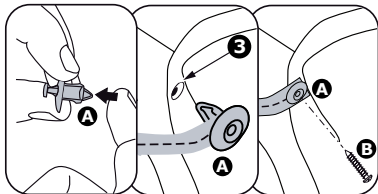

STEP D

I Collegare i due lembi del nastro 3bis e X utilizzando l'aggancio a baionetta, facendo passare il nastro sul retro dello scudo. Tesare i nastri e adattare il Termoscud® in modo che il bordo aderisca all'interno della carrozzeria come in figura.

GB Close the buckles of straps 3bis and X under the leg cover. Behind the bodywork. Tighten up the straps and position Termoscud® so that the edge bonds inside the bodywork, as shown.

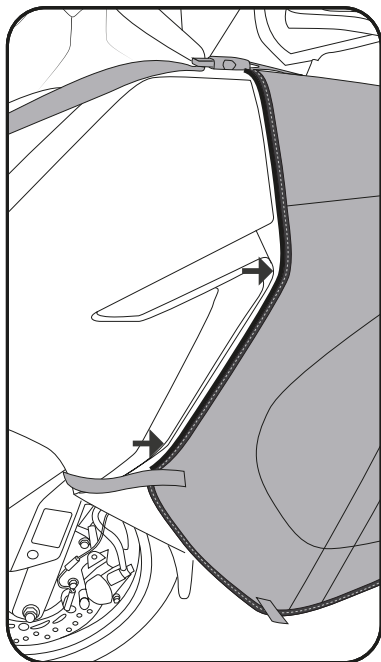
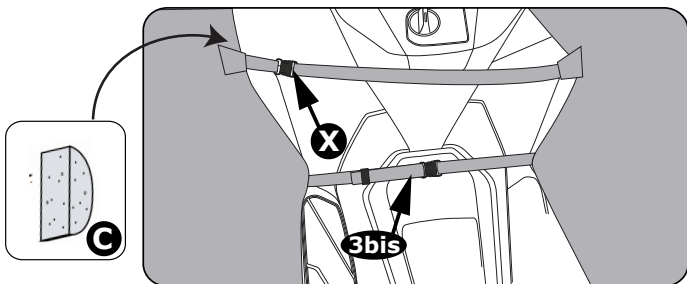

R198 PRO

STEP E

I Rimuovere la vite in plastica dello Scrivet A. Inserire ciò che rimane nel foro 6 all'interno del vano ruota. Quindi fissare nastro 6 con la vite B.

CB Remove the plastic screw from the Scrivet A. Insert the remaining part of the Scrivet into the hole 6 inside the wheel compartment. Then fasten the strap 6 with screw B.

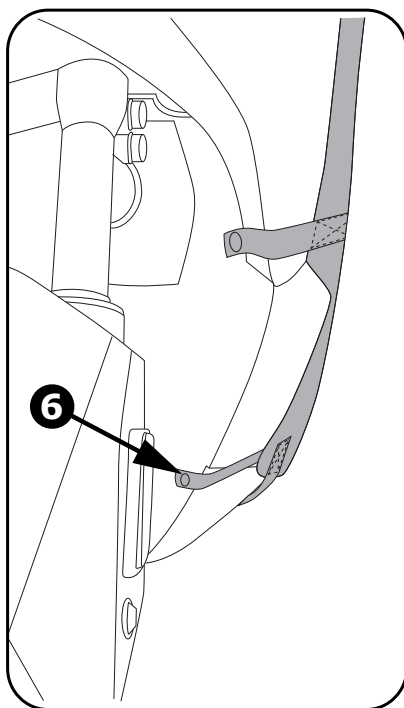
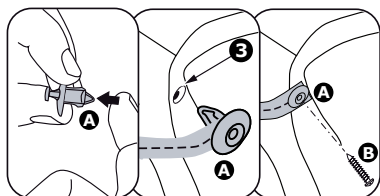

STEP F

I Agganciare la prolunga Y al bordo posteriore della carrozzeria sotto alla pedana. Chiudere il fastex del lato destro. E' possibile tesare i nastri di collegamento da entrambi i lati (2).

GB Attach the extension strap Y to the rear edge of the bodywork below the footplate. Attach the fastex connector on the right side. You can now adjust the length of the extension strap Y by pulling on two connecting straps (2).

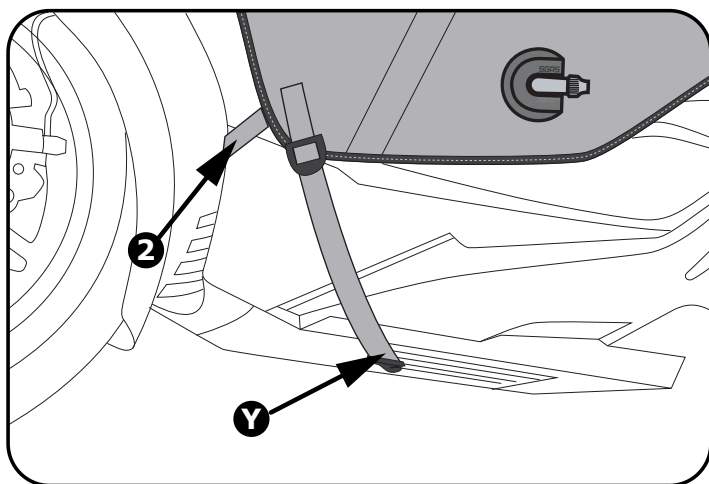



Tucano Urbano S.r.l.
Via Dell'Annunciata, 21
20121 Milano - Italy

TERMOSCU[®] PRO

INSTRUCTIONS DE MONTAGE

Manual de instrucciones

Honda Forza 125/300 > 2018

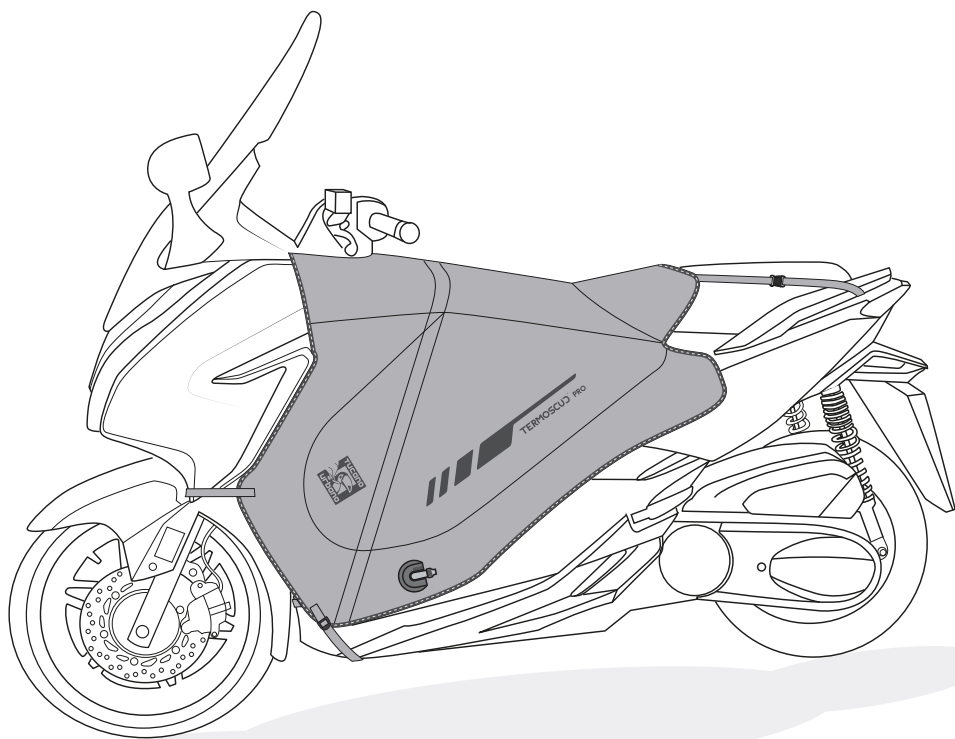

R198 PRO

VUE SOMMAIRE

Vista resumen

KIT DE MONTAGE
Kit de montaje

A  x 4

B  x 4

C  x 2
Adhesive foam

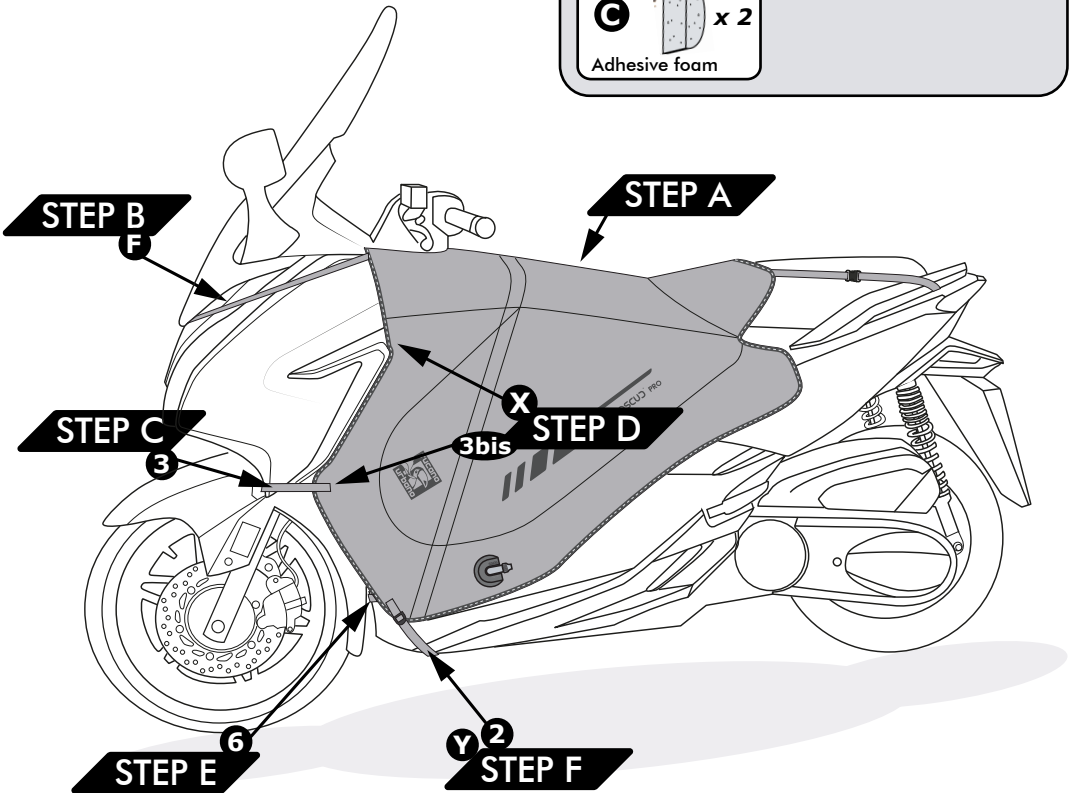

F Les photos et les dessins sont purement indicatifs. Tucano Urbano se réserve le droit de modifier ou améliorer le produit à tout moment, sans préavis et sans obligation d'apporter telles modifications aux produits déjà vendus.

E Las fotos y los dibujos se muestran únicamente a modo de ejemplo. Tucano Urbano se reserva el derecho de modificar o mejorar el producto en cualquier momento, sin previo aviso y sin la obligación de tener que aplicar dichas modificaciones a los productos ya vendidos.

TUCANOURBANO

STEP A

- F** Dérouler Termoscud® sur la selle en mettant les rubans 3 et 6 en avant.
- E** Extienda el Termoscud® sobre el asiento del scooter, de manera que las cintas 3 y 6 queden hacia delante.

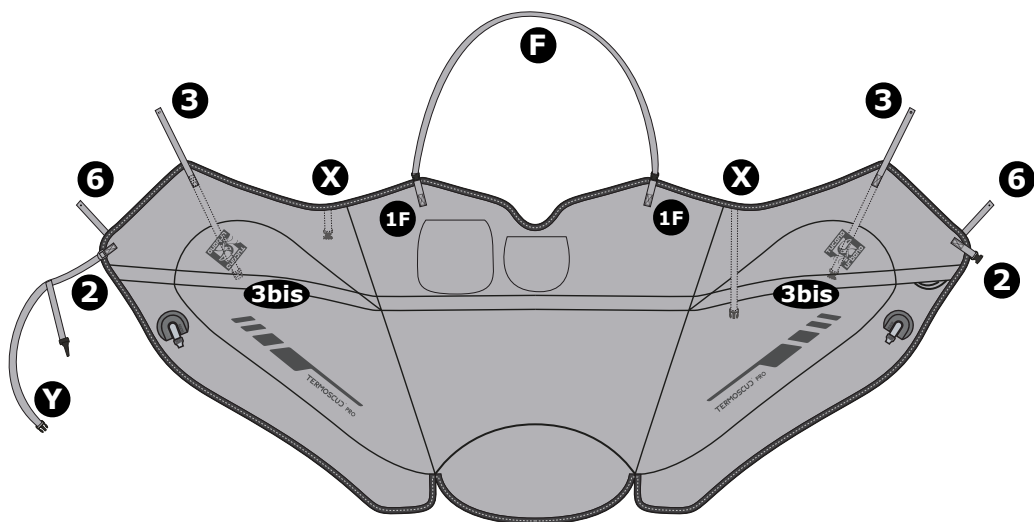

STEP B

F Enfiler le sangle F jusqu'au fond entre le para-brise et le cuvelage du phare. Ensuite accrocher les attaches fastex de sangle F au Termoscud® aux points 1F.

E Tire de la alargadera F lo más posible entre el carenado y la pantalla Perspex. Sujete el Termoscud® con las hebillas fastex en el punto 1F.

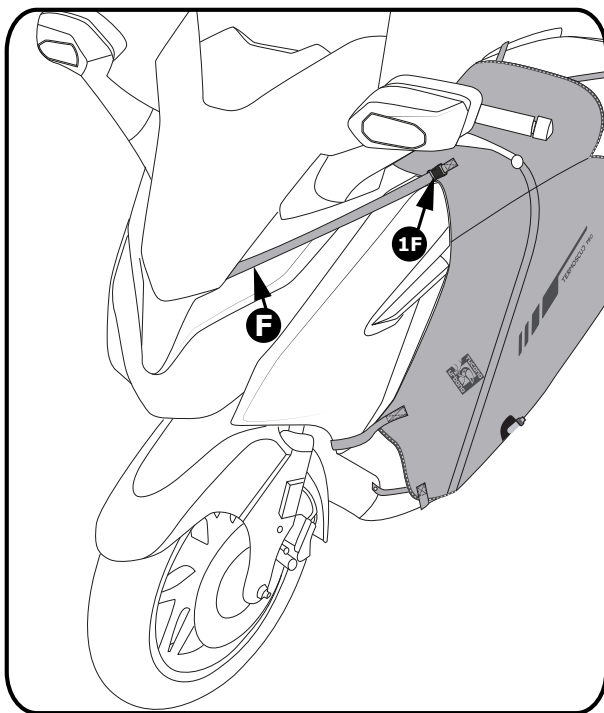

STEP C

F Retirer la vis en plastique du Scrivet A. Introduire ce qui reste dans l'orifice 3 à l'intérieur du compartiment roue. Puis, fixer la bande 3 à l'aide de la vis B.

E Retire el tornillo de plástico del Scrivet A. Introduzca lo que queda en el orificio 3 por dentro del espacio de la rueda. Fije entonces la correa 3 con el tornillo B.

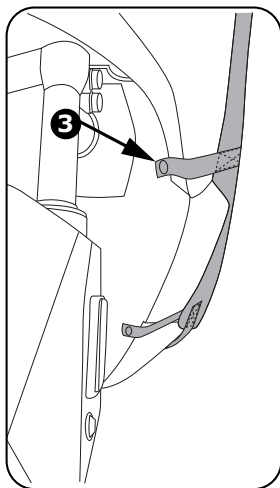
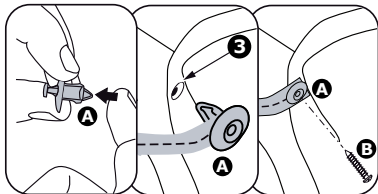

STEP D

F Joindre les deux bouts du ruban 3bis et X à l'aide de l'attache rapide, en faisant passer le ruban à l'arrière du bouclier de protection. Serrer les sangles et positionner Termoscud® de façon que le bord adhère à l'intérieur de la carrosserie, comme montré.

E Cierre la hebilla de la cinta 3bis y X, por debajo Termoscud®, a la altura de las rodillas. Tensar las cintas y adaptar el Termoscud para que el borde se adhiera al interior de la carrocería como se muestra en la figura.

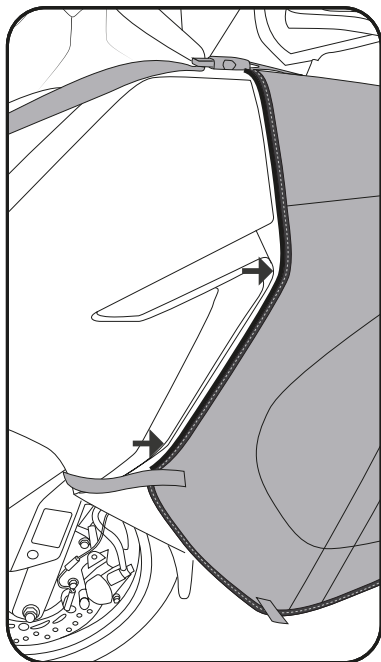
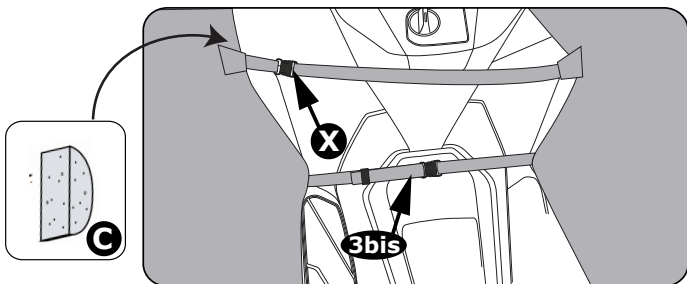

R198 PRO

STEP E

F Retirer la vis en plastique du Scrivet A. Introduire ce qui reste dans l'orifice 6 à l'intérieur du compartiment roue. Puis, fixer la bande 6 à l'aide de la vis B.

E Retire el tornillo de plástico del Scrivet A. Introduzca lo que queda en el orificio 6 por dentro del espacio de la rueda. Fije entonces la correa 6 con el tornillo B.

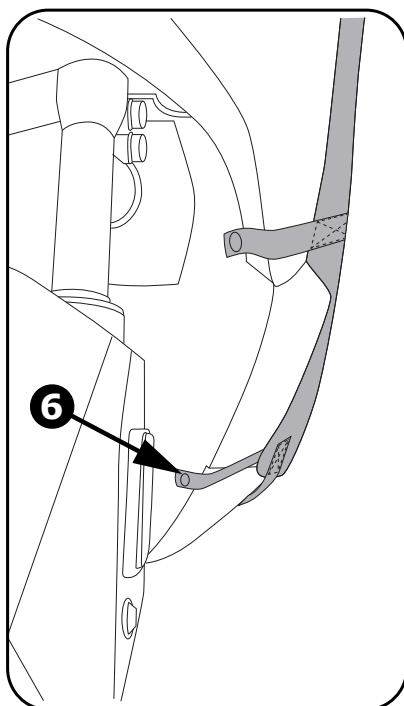
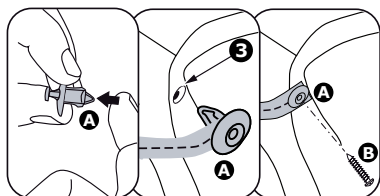

STEP F

F Accrocher la rallonge Y à l'arrière de la carrosserie sous la pédane. Fermer le fastex du côté droit. Il est possible de tendre les sangles des du côtés (2).

E Fije la extensión Y en el borde posterior de la carrocería debajo de la plataforma. Fije la extensión Y en el borde posterior de la carrocería debajo de la plataforma. Cerrar el fastex en el lado derecho. Il es posible tensar las cintas de conexión de ambos lados (2).

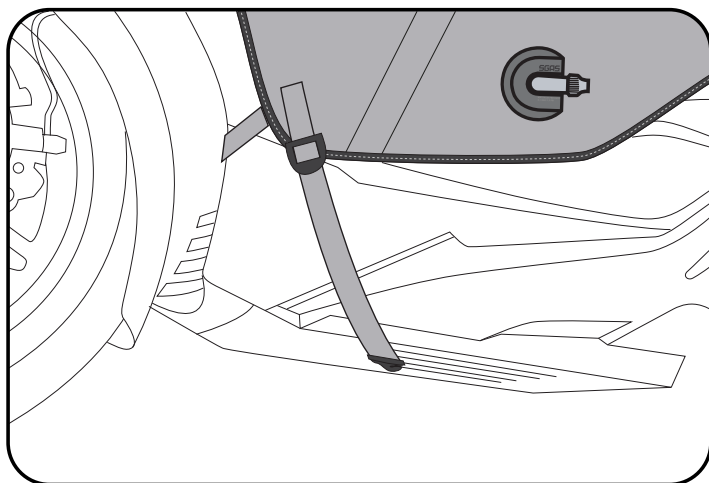



Tucano Urbano S.r.l.
Via Dell'Annunciata, 21
20121 Milano - Italy